

NICHES WITH LED & NICHES WITHOUT LED

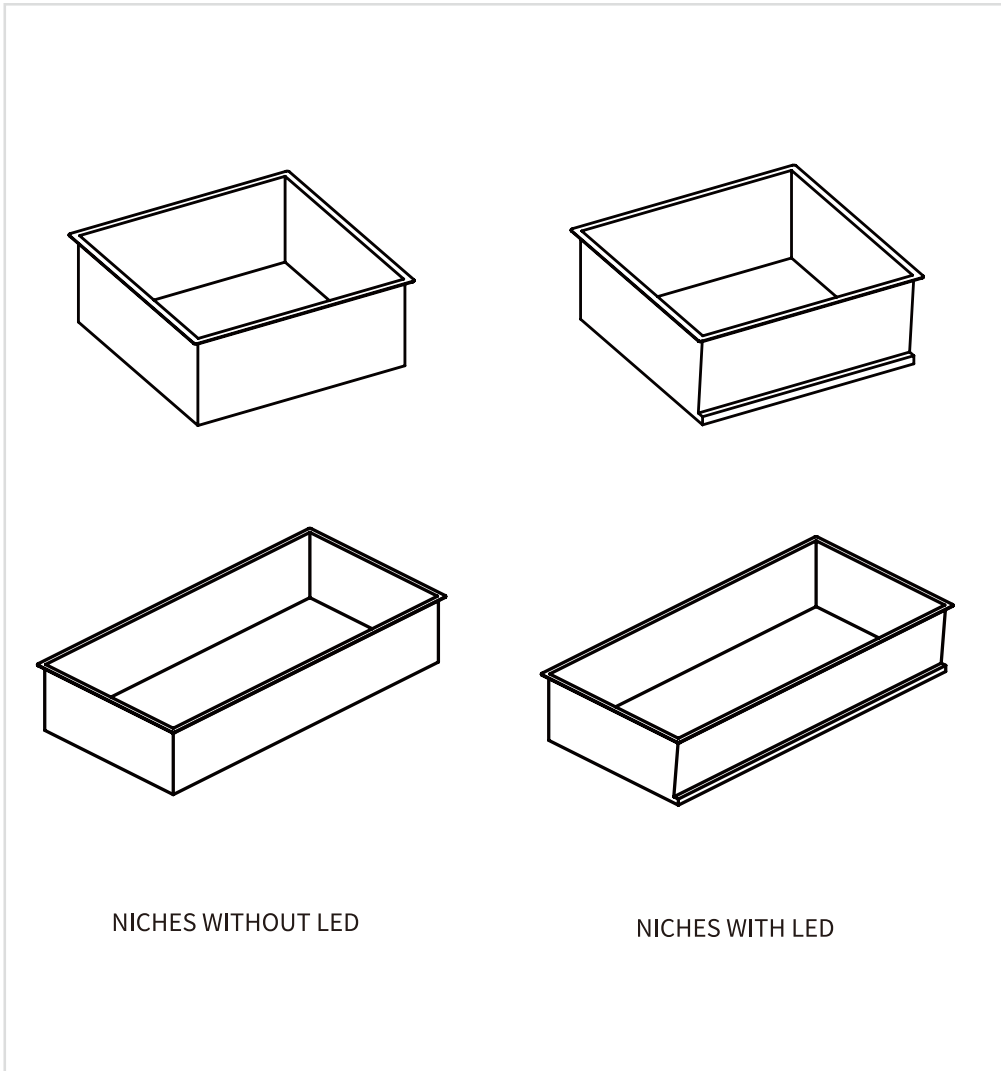

PRODUCT CODES:

NI305305MB	NI305305LMB
NI305305F	NI305305LF
NI305305V	NI305305LV
NI305305BZ	NI305305LBZ
NI305305T	NI305305LT
NI305610MB	NI305610LMB
NI305610F	NI305610LF
NI305610V	NI305610LV
NI305610BZ	NI305610LBZ
NI305610T	NI305610LT



IMPORTANT INFORMATION

Please read carefully and keep this information for further reference.

Check the contents of the pack carefully before installation. Responsibility will not be held for any de-fit / re-fit costs where faulty product has been fitted. If any fault is found with materials or workmanship, it must be reported immediately to the manufacturer. Remedial action will be taken, based on information received, on condition that:

1. Full details are supplied to the manufacturer;
 2. The product has not been modified or tampered with;
 3. The manufacturer is informed of any damage/shortages prior to installation.
 4. The product has not been installed, or attempts made to install. We do not accept responsibility for any problems that may occur through incorrect installation. ENSURE the room is well heated and ventilated.
- Any modification to the supplied product will negate all product guarantees.



IMPORTANT INFORMATION

BEFORE YOU START

Before drilling ensure there are no hidden cables or pipes (water, gas or electrical) behind mounting points. Always wear suitable eye protection when drilling. Ensure the wall surface is able to take the weight of the complete product.

Please follow the correct installation method. If the instructions are not followed appropriately there is an increased safety risk to the user.

It is important to install electrical bathroom products in the correct bathroom zone.

It is recommended that all electrical bathroom products should only be fitted by a suitably qualified, Part P registered electrician in accordance with current IEE regulations. Failure to have electrical products installed and certificated by a qualified electrical engineer will invalidate any product guarantee. For full details reference should be made to the latest copy of the IET wiring regulations and all applicable British Standard and European norm specifications.







BEFORE YOU START

Warning!

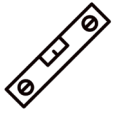
When using power tools always follow the manufacturers user instructions.

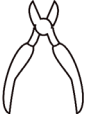
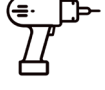
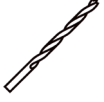
Leave the silicone sealant to dry for 24 hours before using the niches.

Tools Required (not supplied):

Spirit Level		Torque Screw Driver	
Pencil		Snips	
Drill		6mm Drill Bit	
Silicone		Measuring Tape	
Knife			

INSTALLATION

1

Before installation, the opening in the wall should be prepared to the appropriate size for your niche.
 (For Niche with LED, make a notch in the wall on top or side. Make sure this notch large enough for the transformer supplied. From this notch the transformer is connected to the mains. In preparation power cables to the mains, with a switch you can turn the lights on and off. Please note, there is no switch incorporated in the niche.)

The niche is not suitable for use in a load bearing wall and the wall thickness should be no less than 150mm.

When choosing the position for your niche it is advised that it be as far away from the joint of the ceramic tile as possible. This will minimise the risk of cracking the tiles and break and ensure that the product is installed securely.

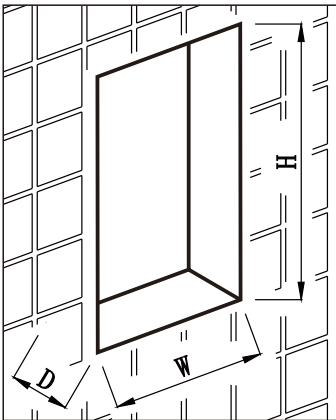

Additional step for Niche with LED :

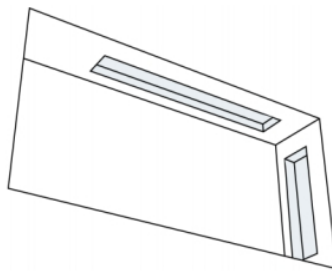

Make a notch in the wall on top or side.

Remove the cover from the electrical connection box. Using a suitable terminal screwdriver to secure connections as follows:

Colour Coding:
 L - Live = Brown
 N - Neutral = Blue
 Earth = Green & Yellow

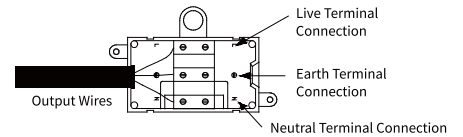

2

When installing, wipe the niche surface and the opening in the wall first. Apply beads of silicone adhesive to wall surfaces inside the opening and to the edge trim of the niche.

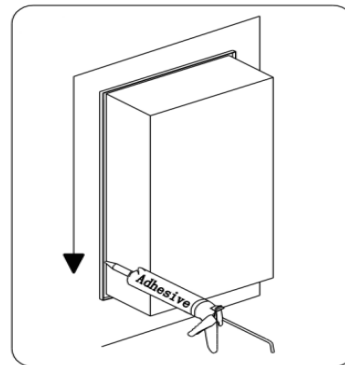
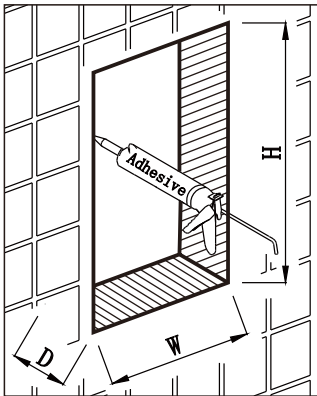

3

Insert the niche into the opening and secure with tape to initially hold in place.
 Leave the silicone sealant to dry for 24 hours before using the Niche.

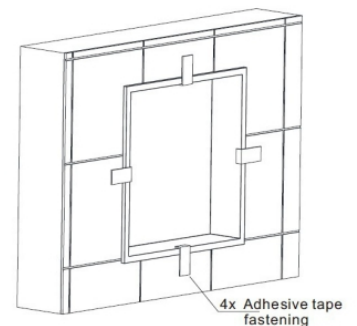

TECHNICAL DRAWING

SIZE 305*305mm WITHOUT LED LIGHTING

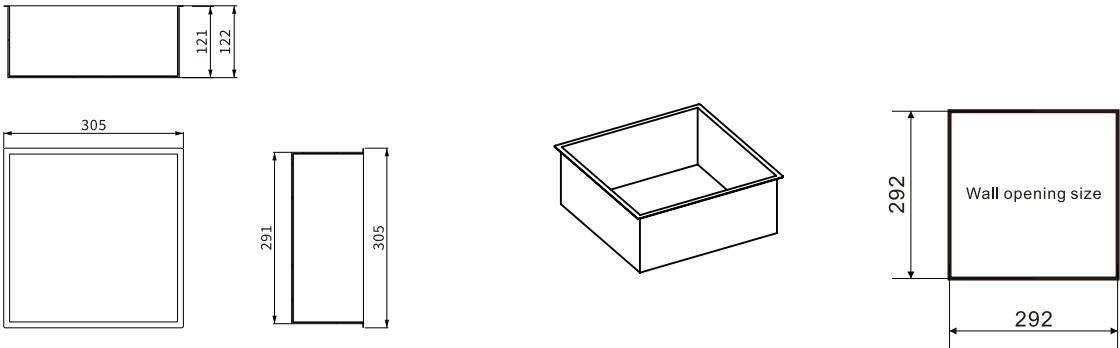

SIZE 305*305mm WITH LED LIGHTING

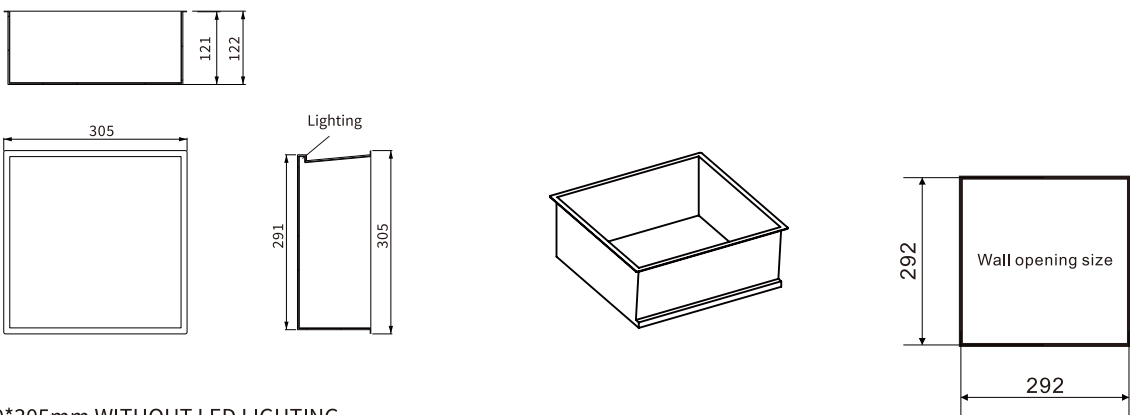

SIZE 610*305mm WITHOUT LED LIGHTING

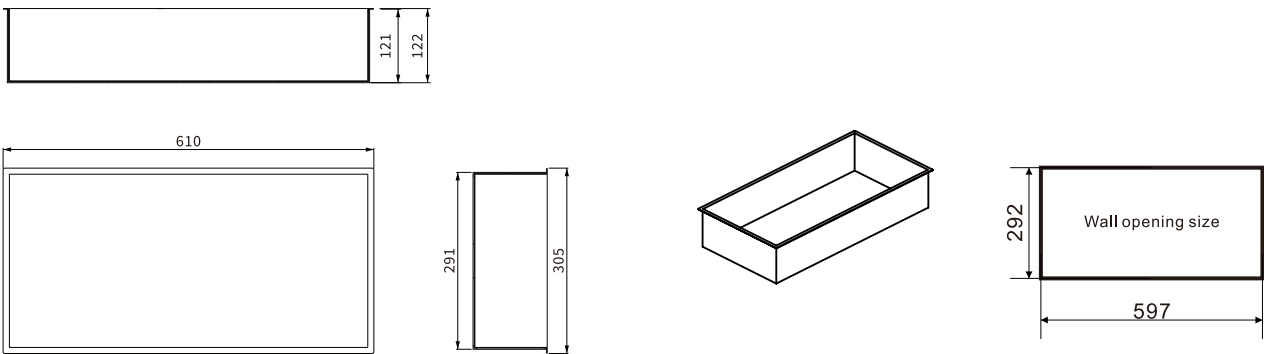

SIZE 615*305mm WITH LED LIGHTING

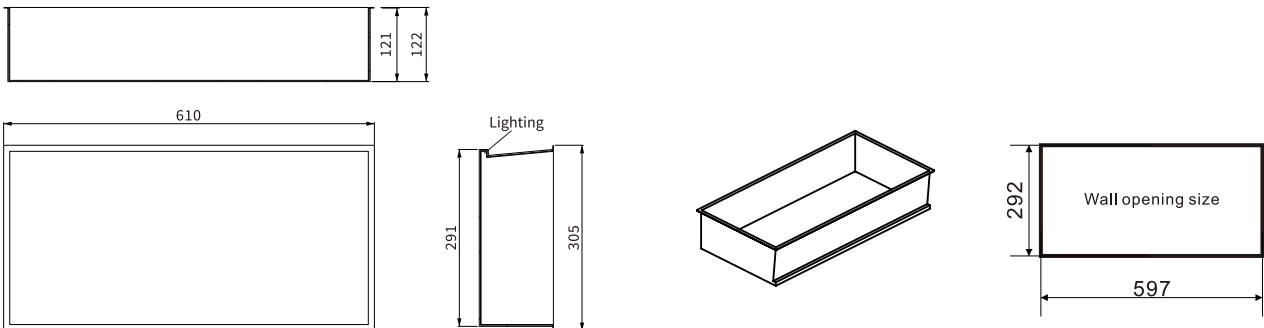

CARE & MAINTENANCE

Do not use solvents or abrasive materials or chemicals to clean products.

PH < 6.8, PH > 7.2

Only use soapy water and soft cloth, rinse thoroughly afterwards.

PH = 6.8 - 7.2

