

PRODUCT DATA SHEET



PRODUCT CODE

GL0611SMB

RANGE

GLIDE II

DESCRIPTION

600mm Basin 1TH Midnight Black

COLOUR Midnight Black

MATERIAL Glass

STANDARDS EN 31
EN 14688 - CLO

INSTALLATION TYPE Furniture Mounted

CAPACITY OF WATER AT OVERFLOW LEVEL 15 L

BASIN WASTE SIZE 45mm

TAP HOLES 1TH

OVERFLOW Yes

WEIGHT 8.3kg

WARRANTY 10 Years

TECHNICAL DIMENSIONS

Dimensions in mm unless otherwise specified.

Tolerances (per material type) apply.

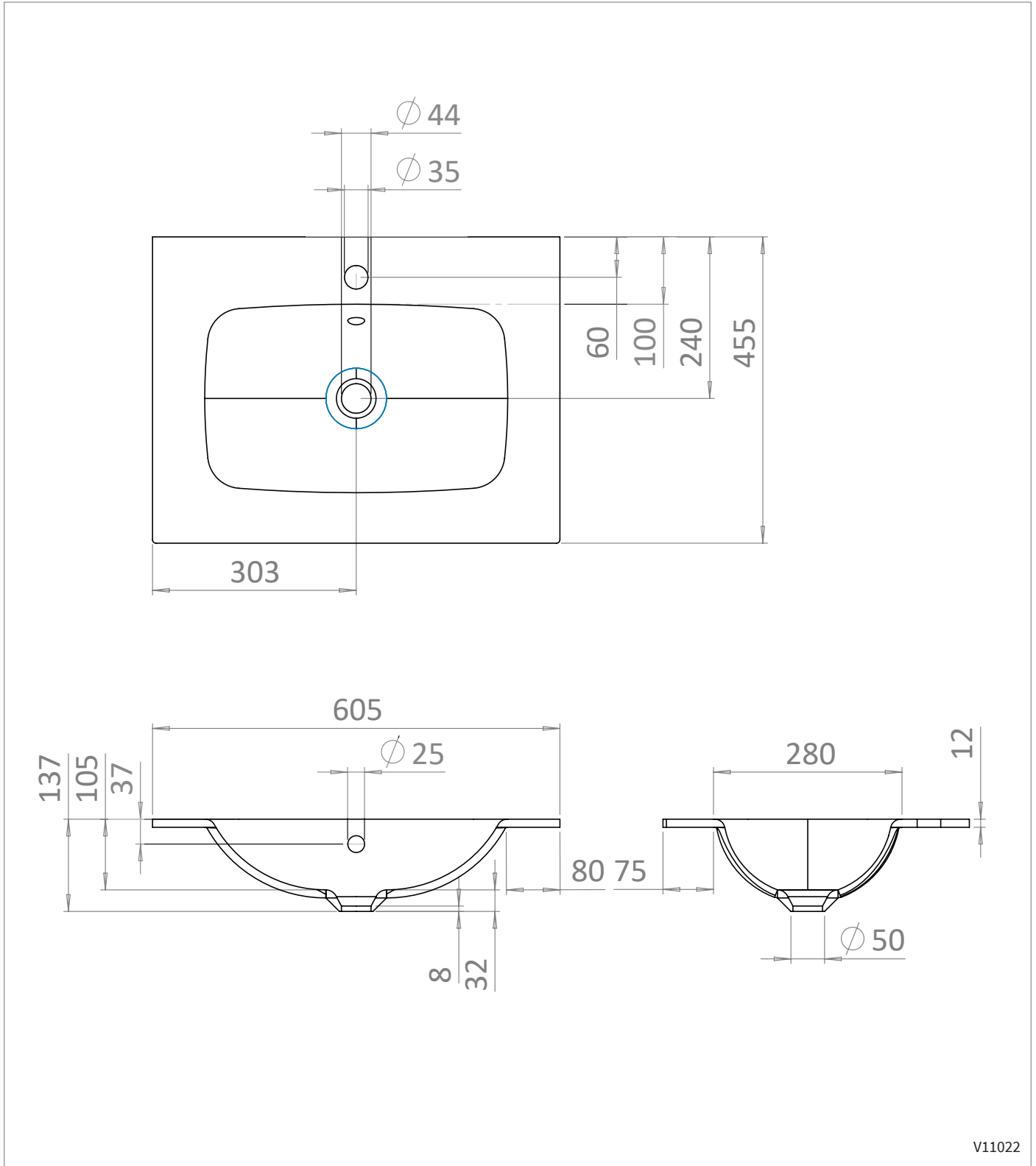

V11022