

PRODUCT DATA SHEET

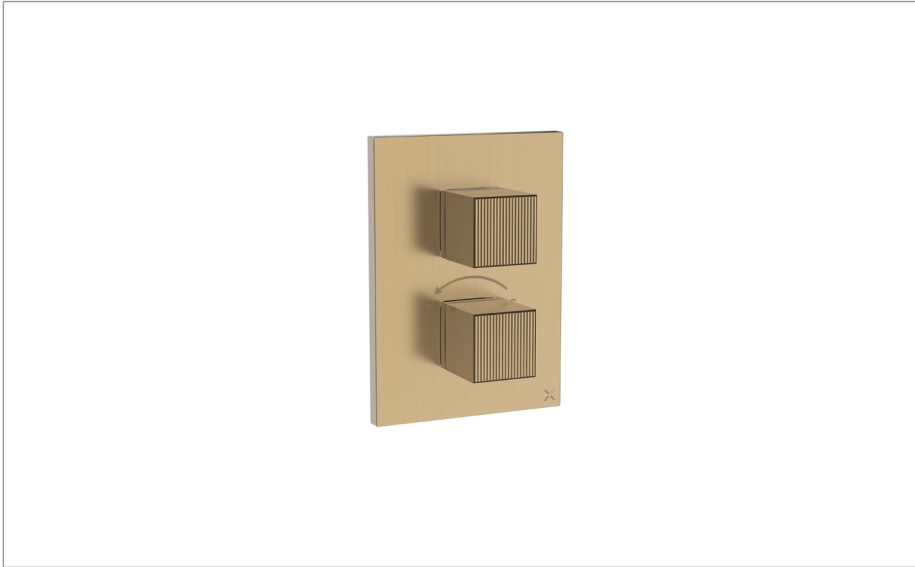

PRODUCT CODE

LICB2500LBPF

RANGE

Limit

DESCRIPTION

Crossbox Limit 3 Outlet Trim & Valves
Brushed Brass

WEBSITE LINK [Click Here](#)

CATEGORY	Brassware
WARRANTY DETAILS	15 Years
COLOUR	Brushed Brass
FINISH APPLICATION	PVD
PRIMARY MATERIAL	Brass
INSTALL TYPE	Wall Mounted
PRODUCT WIDTH MM	130
PRODUCT HEIGHT MM	180
PRODUCT DEPTH MM	59
PRODUCT NET WEIGHT	1.64

MINIMUM PRESSURE (BAR)	1
MAX WORKING PRESSURE (BAR)	5
NUMBER OF OUTLETS	3
HEADWORK	35mm
INLET CONNECTIONS THREAD	G1/2"
WASTE INCLUDED	No
ANTI-SCALD	Yes
ENERGY SAVING	No
SHOWER HOSE & HANDSET ARE INCLUDED	No

PRESSURE (BAR)	0.2	0.5	1	2	3	4	5
PRIMARY FLOWRATE			11.7	16.7	20.7	24	26.6
HANDSET FLOWRATE							
MESSAGE FLOW RATE							
AIR FLOW RATE							
WIRE FLOW RATE							
WATERFALL FLOW RATE							
MIST FLOW RATE							
HANDSPRAY FLOW RATE							

TECHNICAL DIMENSIONS

Dimensions in mm unless otherwise specified.

Tolerances (per material type) apply.

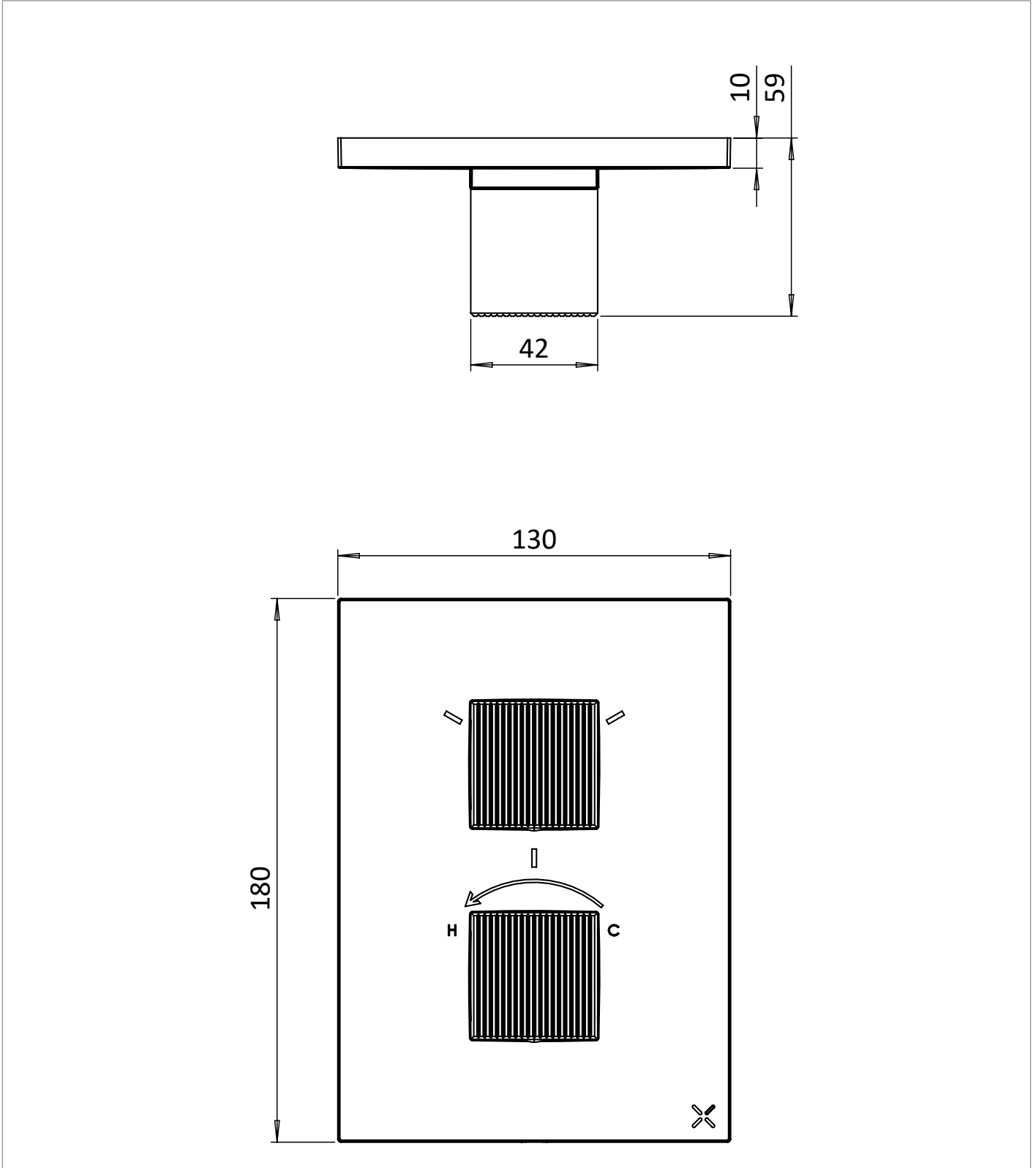

SPARES LIST

Only the parts labelled are available as spares.

--