

WLBP2000RC+ - Thermo Shower Valve no Levers & Backplate

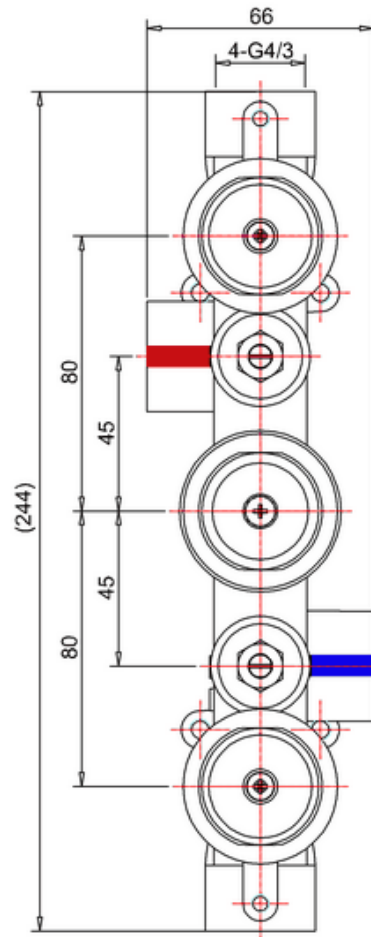
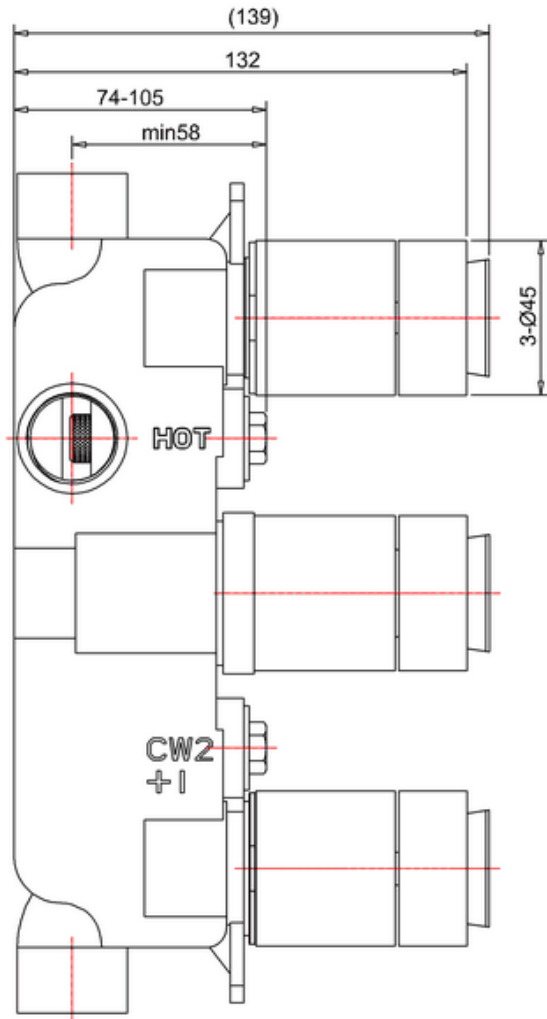

Note:

For each part of the accessory, the dimension tolerance should be followed the list below.

0 ~ 100	101 ~ 200	201 ~ 400	≥ 401
±1	±2	±3	±5

For the finished assembly, the dimension tolerance should be followed the list below.

0 ~ 300	≥ 301
±2	±5

