

PRODUCT DATA SHEET



PRODUCT CODE

SE8000DSG

RANGE

SVELTE

DESCRIPTION

800mm Basin Unit Storm Grey

COLOUR	Storm Grey
COLOUR CODE/ REFERENCE	Crosswater Exclusive
MATERIAL	16mm and 18mm MDF/MFC Solvent Free Acrylic Lacquer
STANDARDS	EN 13986 EN 14749
INSTALLATION TYPE	Wall-Mounted
DRAWER BOX	Textile Finish MFC Concealed Runners
DRAWER RUNNERS	BLUM Tandem Box - Soft Close Pull To Open
DRAWER EXTENSION	Full Extension
DRAWER ADJUSTMENT	3 Way
DRAWER CAPACITY	30kg
WALL HANGERS	CAMAR With Safety Lock - Factory Fitted 120kg Load Capacity On A Solid Wall 3 Way Adjustment
WEIGHT	33kg
WARRANTY	10 Years

TECHNICAL DIMENSIONS

Dimensions in mm unless otherwise specified.

Tolerances (per material type) apply.

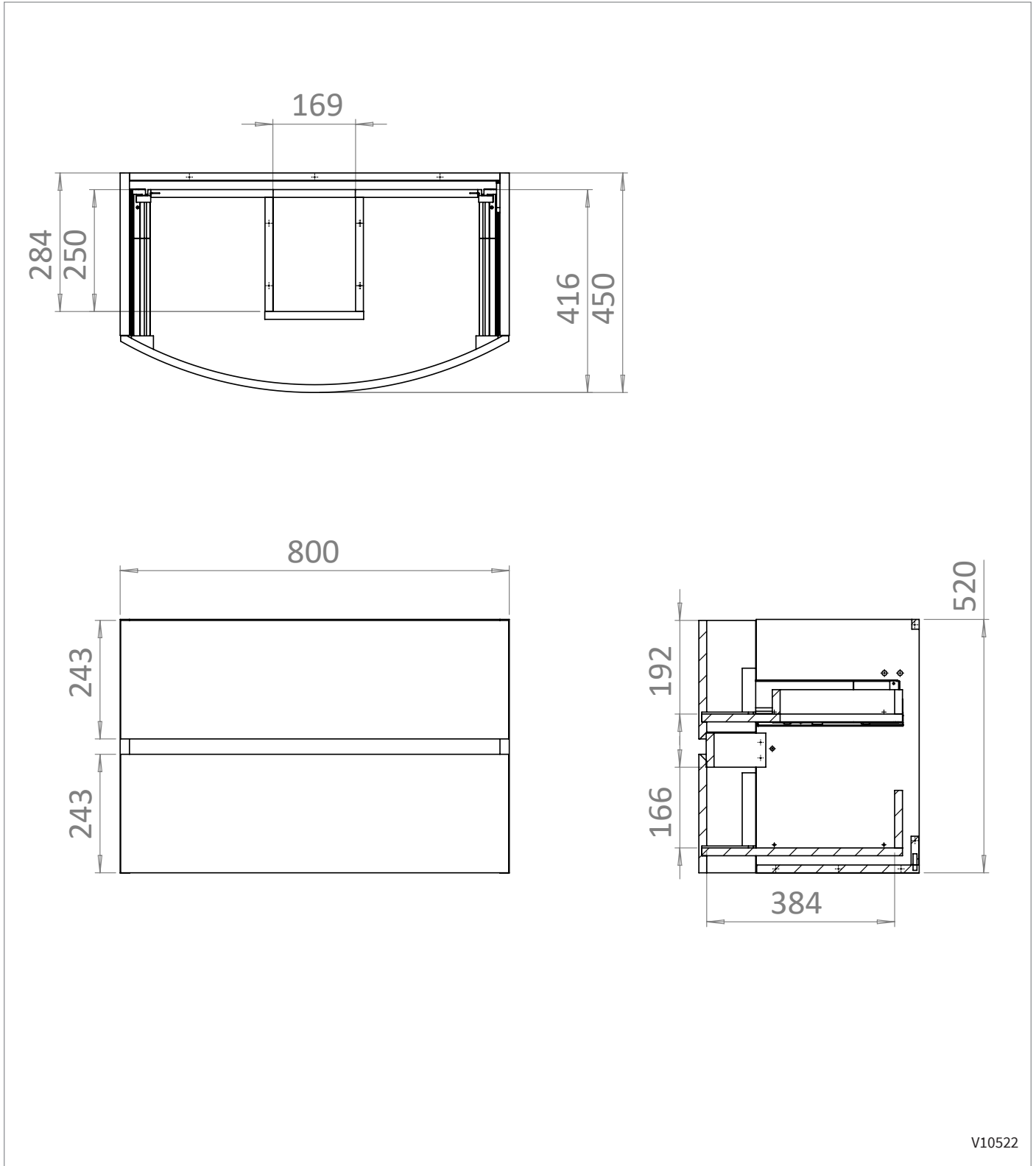

V10522

SPARES DIAGRAM

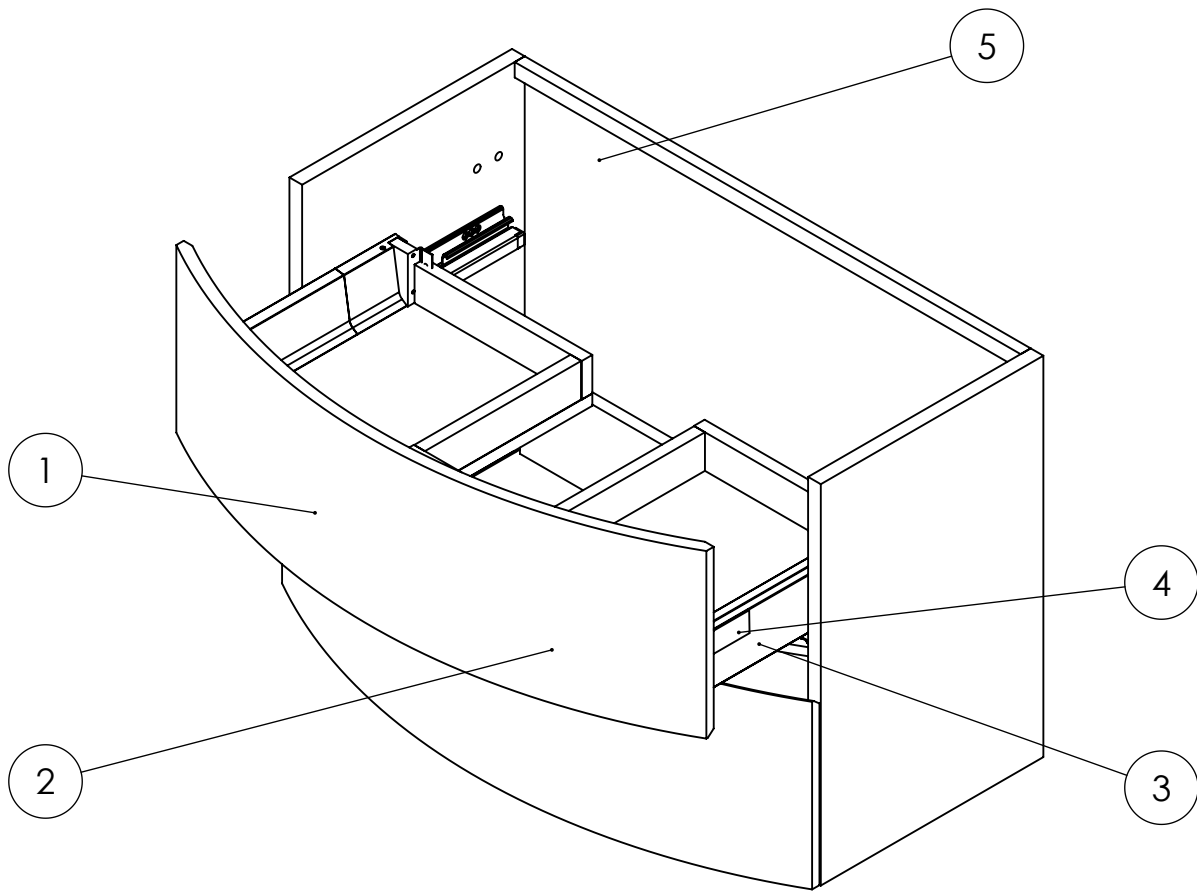

Only the parts labelled are available as spares.

V10522

SPARES DIAGRAM

NUMBER	PART CODE	DESCRIPTION
1	TDF_80SEDGA	Top Drawer Front from SE8000DGA
	TDF_80SEDSG	Top Drawer Front from SE8000DSG
	TDF_80SEDWG	Top Drawer Front from SE8000DWG
	TDF_80SEDAW	Top Drawer Front from SE8000DAW
	TDF_80SEDOB+	Top Drawer Front from SE8000DOB
	TDF_80SDCO+	Top Drawer Front from SE8000SDCO+
2	BDF_80SEDGA	Bottom Drawer Front from SE8000DGA
	BDF_80SEDSG	Bottom Drawer Front from SE8000DSG
	BDF_80SEDWG	Bottom Drawer Front from SE8000DWG
	BDF_80SEDAW	Bottom Drawer Front from SE8000DAW
	BDF_80SEDOB+	Bottom Drawer Front from SE8000DOB
	BDF_80SDCO+	Bottom Drawer Front from SE8000SDCO+
3	RUNNERS_SVELTE	Drawer Runners from the Svelte Furniture
4	SECLIPS	Svelte Drawer Covers x4
5	WB897ASZ16070	Wall Bracket x2

We recommend purchasing the top and bottom drawer fronts for the following codes to ensure the continuity of the naturally formed veneer pattern:

American Walnut

Castilla Oak

Grey Ash

Only the parts labelled are available as spares.

V10522