

Measurements in millimetres mm
Information updated January 2016
tel 0345 873 8840

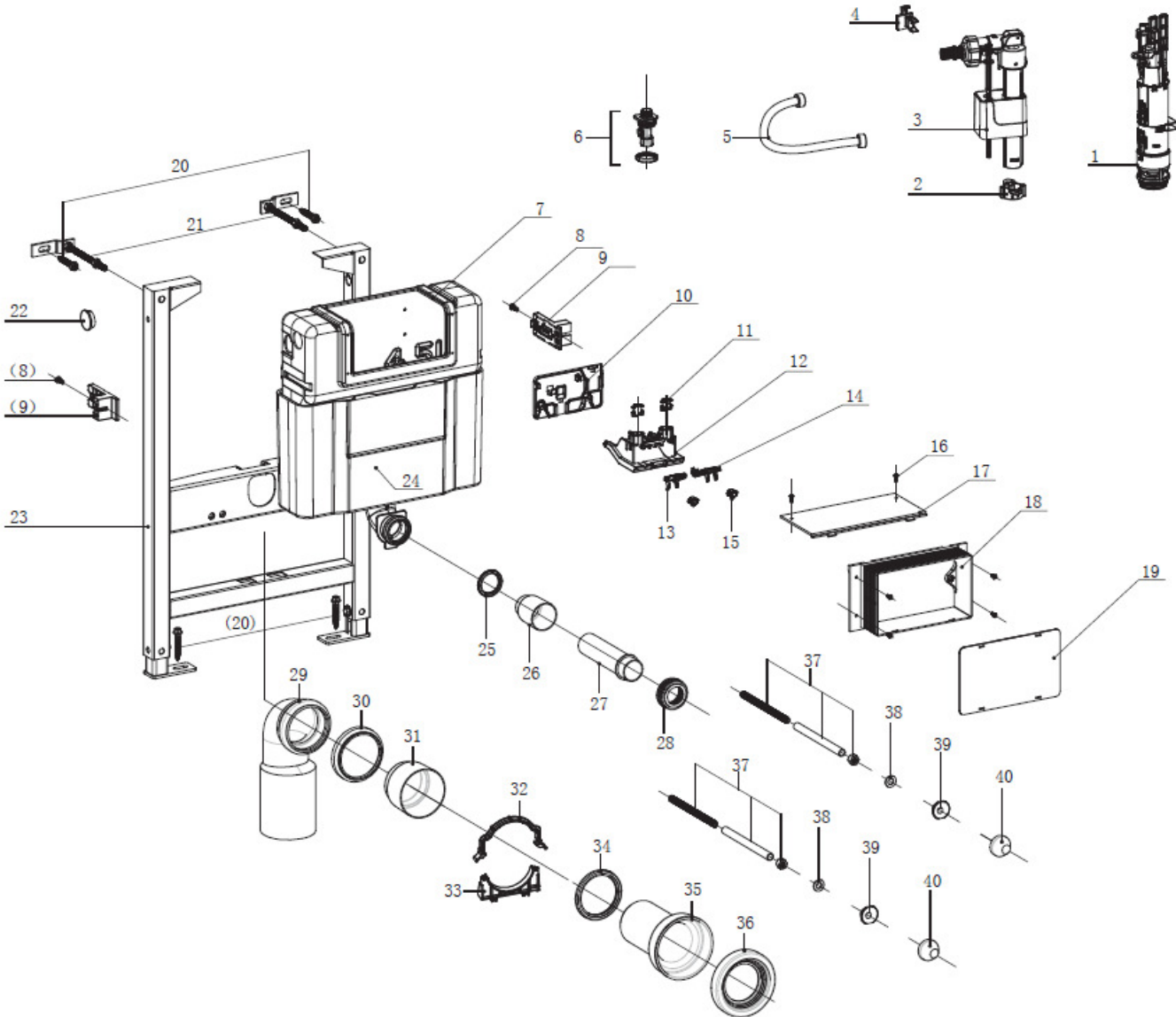

Measurements in millimetres mm

Information updated January 2016

Tel 0345 873

crosswater[™]

No.	Description	Quantity
1	Dual Flush	1
2	Fill Sleeve	1
3	Fill Valve	1
4	Fill Clip	1
5	Soft Pipe	1
6	Angle Valve	1
7	Tank Component	1
8	Screw	2
9	Tank Hook	2
10	Fixing Plate	1
11	Adjust nut	2
12	Gearing Bracket	1
13	Full Swing Arm	1
14	Half Swing Arm	1
15	Adjust nut	2
16	Screw	6
17	Protection Cover	1
18	Protection bracket	1
19	Protection Cover	1
20	Expansion bolt	4
21	Wall fixation	2
22	Inlet Cover	1
23	K8044 Frame	1
24	Foam	1
25	Seal Ring	1
26	Embedded Part	1
27	Straight Scour	1
28	Seal Sleeve	1
29	Waste Elbow	1
30	Waste Elbow cover	1
31	Embedded Part	1
32	Top Pipe Clip	1
33	Down Pipe Clip	1
34	Seal Ring	1
35	Straight Pipe	1
36	Seal Sleeve	1
37	Bolt Component	2
38	Washer	2
39	Gasket	2
40	Nut Cap	2

bauhaus[™]

0.98m WC Frame Support and cistern

Floor Mounted

WCF98X50+